



BRIEFING FOR WARRIORS 2024

Race like nowhere else...





01

GENERAL

DÉROULEMENT DE L'ÉPREUVE / PROOF OF THE EVENT

Respect strict des drapeaux et des feux lumineux.

Respect des consignes des commissaires de piste.

Respect de tous les officiels et des bénévoles.

En cas d'incident sur la piste, mettre son kart en sécurité le plus rapidement possible.

Interdiction de changer de trajectoire dans le seul but d'empêcher un autre concurrent de doubler.

Convivialité, fair play et rigueur. Aucun comportement antisportif ne sera accepté.

Strict respect for flags and led flags,

Respect of the instructions of the track marshals.

Respect for all officials and volunteers.

In the event of an incident on the track, put your kart in safety as quickly as possible.

Prohibition to change course for the sole purpose of preventing another competitor from doubling under pain of penalty

Conviviality, fair play and rigour. No unsportsmanlike behavior will be accepted.

90	L. FLU	8 Laps
947	M. SMI	+2.165
927	M. MAC	+2.467
981	D. COS	+2.548
919	M. GUT	+3.896
902	S. VAN	+3.258
965	E. BIE	+3.765
962	N. BAG	+5.761
971	T. PRA	+5.791
955	R. KAM	+5.848
933	R. SEA	+5.861
812	J. ASH	+5.943
949	M. COR	+6.818
909	J. EDG	+6.182
982	B. COS	+6.411
930	R. ZUN	+6.491
948	H. MAR	+6.778

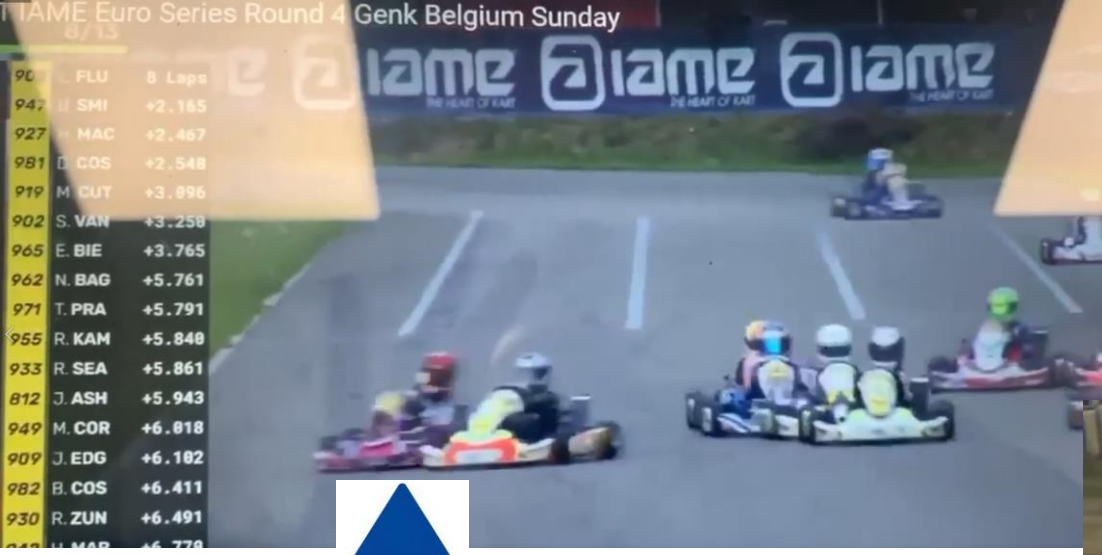

IAME GENK FINAL			
LAPS 3 / 21			
1	N. PIC	296	3 Laps
2	H. THO	379	+0.022
3	J. VAN	204	+0.110
4	C. TES	262	+0.079
	J. TUR	205	+0.186
6	E. HAR	291	+0.252
7	T. TUR	224	+0.457
8	C. RAV	203	+1.815
9	R. VIV	235	+0.163
10	C. MC	299	+0.289
11	O. HOD	201	+0.087
12	M. KIM	247	+0.183
13	J. NOR	208	+0.201
14	V. OBE	243	+0.237
15	E. BOR	274	+0.110
16	S. LEE	341	+0.106
17	P. RAW	229	+0.125

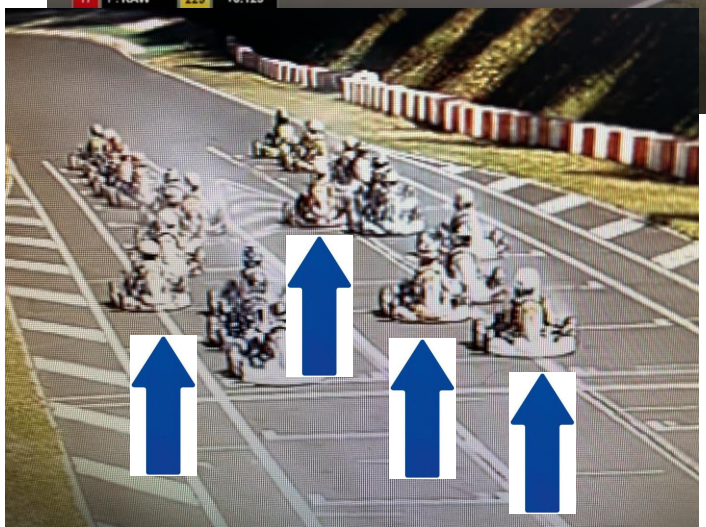

DRAPEAUX / FLAGS

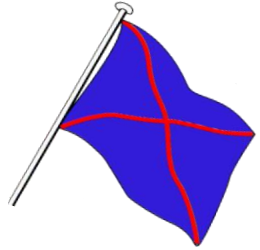

Arrêt du pilote avant qu'il soit doublé / Stopping the driver before it is doubled



Problème technique, retour à l'aire de réparation / Technical problem return repair area

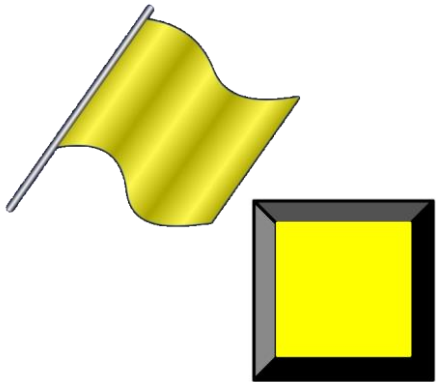

Danger, Ralentir, et défense de dépasser / Danger ! Slow down and defending an opponent



Retour *immédiat* au parc arrivée et rencontre avec le directeur de course / Return to the arrived park and report to the clerk of the race



Faux départ / False start



Avertissement / Warning

SPOILER AVANT / FRONT FAIRING

DESSIN TECHNIQUE N° 2d

Installation correcte du «Carénage Avant»

Position correcte / Correct position

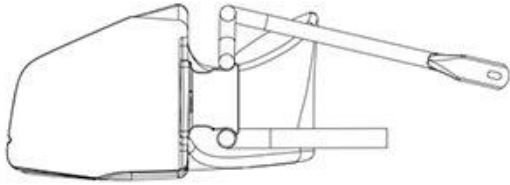

TECHNICAL DRAWING No. 2d

Correct installation of the "Front Fairing"

Position acceptable / Acceptable position

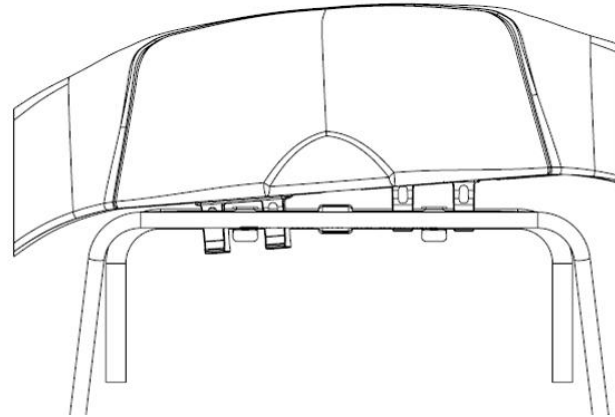
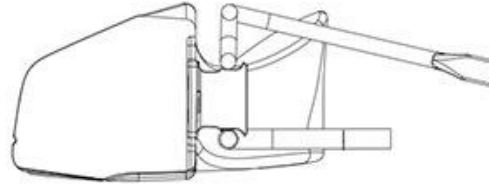

Dans le Parc Assistance « Arrivée », à l'issue de la course, rester assis dans le kart tant que le spoiler n'a pas été contrôlé !

In the Assistance "Arrival" park, at the end of the race, stay in the kart until the spoiler has been controlled!

Pénalité de 5s
5s Penalty

CHAUFFE MOTEUR / HEAT ENGINES



La chauffe ou les essais moteurs sont strictement interdits dans les paddocks, les parkings ou le Parc Fermé. Il est seulement autorisé de vérifier que le moteur démarre dans le Parc Départ, après accord d'un Contrôleur Technique.

Heating or engine tests are strictly forbidden in paddocks, car parks or the Parc Fermé. It is only allowed to check that the engine starts correctly, in the Departure Parc, after a Scrutineer agreement.



02

SPECIFIQUE

Présentation des officiels / Staff of the race

Directeur de course / Clerks of the race :

Dante BANCHIO
Gilbert DAMON
Eric LHERMITTE

Collège des Commissaires Sportifs / Stewards college :

Bernard NAVARRO
Dominique JOUIN
Odette DEJUNIAT

Juges de Faits / Judges of Facts :

Alain PONCE
Cathy PERRONNET
Isabelle LEFEBVRE

Contrôle licence : Elodie GLOAGUEN

Pré-grille / Pregrid :

Fabian EUCHAMPS
Isabelle LEFEBVRE

Contrôleurs Techniques / Scrutineers :

Jean-Pierre BAUDRY
Monique BAUDRY
Daniel DEJUNIAT
Paolo D'AMICO
Laurent CLAPAREDE
Michel BORGEAUD
Jacqueline BORGEAUD

Chronométrage / Timekeeping : Patricia FARGUES Serge TERRASSE

Relation Concurrent / Competitor Relationship : Olivier CEBE

Commentateur : Jack ZORBA

Docteur : Laurent KLINGER

Drapeau rouge /
Red Flag



Secours / Medical



Tableau d'affichage /
Official board

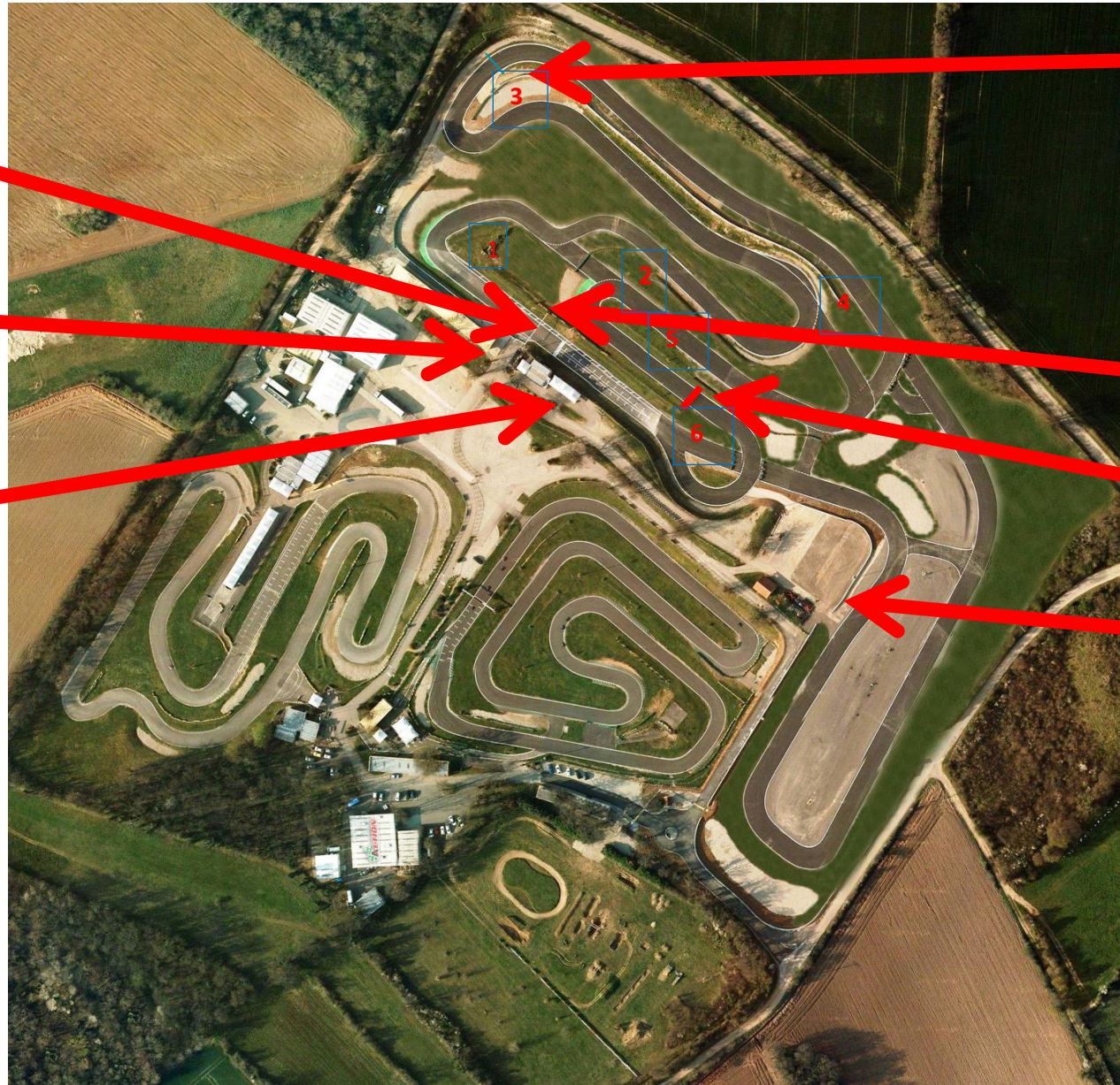

Panneau Formation /
Formation board



Faux départ /
False start



Ligne rouge /
Red Line

Podium



QUELQUES RAPPELS



1. 2 tours de formation,
2. Tout arrêt pendant les essais chronométrés est définitif.
3. Retour au Parc d'Arrivé après le drapeau à damier, 1 tour de décélération,
4. Vélo, trottinette électrique,... interdit dans le paddock ! 
5. Le drapeau d'avertissement, présenté 2 fois au même pilote au cours du week-end, entraînera une pénalité automatique de 5 secondes,
6. Tapis de sol ou bâche obligatoires,
7. Accès véhicules dans paddock strictement interdit, même pour décharger.
8. Pour les pénalités de sortie de couloir (2 roues et 4 roues) ainsi que les pénalités jusqu'à 5 secondes, le pilote et son concurrent ne seront pas convoqués à la Commission Sportive (Art 12.4.4 du Code Sportif International).
9. A partir du panneau formation, se mettre sur 2 files, et avoir une vitesse constante et pas trop rapide.



SOME REMINDERS



1. 2 formation laps,
2. Any stoppage during timed practice is final.
3. Return to the Arrival Park after the checkered flag, 1 lap of deceleration,
4. Bicycles, electric scooters, etc. prohibited in the paddock!
5. The warning flag, shown twice to the same driver during the weekend, will lead to an automatic penalty of 5 seconds,
6. Groundsheet or tarpaulin mandatory,
7. Vehicle access to the paddock strictly prohibited, even to unload.
8. For lane exit penalties (2 wheels and 4 wheels) as well as penalties of less than 5 seconds, the driver and his competitor will not be summoned to the Sporting Commission (Art. 12.4.4 of International sporting code).
9. From the formation panel, get into 2 lines, and have a constant speed and not too fast.



TABLEAU DE BORD DIGITAL EN PISTE DIGITAL BOARD + FLAG/BOARD AT TRACK SIDE

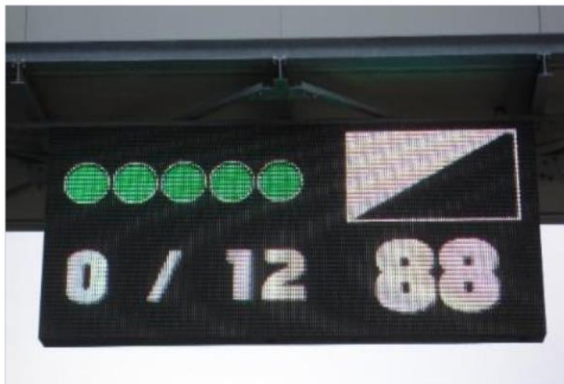

ACCES PARC D'ASSISTANCE / ASSISTANCE PARK ACCESS



1 pilote + 1 mécanicien + 1 kart en même temps !!
1 driver + 1 mechanic + 1 kart at the same time!!

DEROULEMENT DE L'EPREUVE / PROOF OF THE EVENT

Warm-up :

08 Minutes

Essais qualificatifs / Qualifying Practice :

06 Minutes

Manches qualificatives / Qualifying Heats :

10 minutes + 1 tours / 10 minutes + 1 lap

Super Manche / Super Heat :

12 minutes + 1 tour / 12 minutes + 1 lap

Finale / Final :

16 minutes + 1 tour / 16 minutes + 1 lap

14 minutes + 1 tour / 14 minutes + 1 lap (Mini 60)



En cas de pluie, durée
identique

In case of rain, same
period





03

DEPART &
ARRIVEE

PROCÉDURE DE DÉPART

Présence à l'entrée du parc départ 15 minutes avant l'heure de départ de la course, carénage avant démonté,

Fermeture prégrille, 5 minutes avant l'heure de départ (Aucune mécanique en prégrille),

Evacuation mécaniciens, 3 minutes avant le départ ,

Toute intervention du mécanicien implique un départ à l'arrière du peloton, même en zone de réparation pendant les tours de formation, sous peine de se voir présenter le drapeau noir,

2 tours de formation,

Regroupement au panneau « FORMATION »,



Possibilité de reprendre sa place jusqu'à la ligne rouge,

Restez dans les couloirs et accélération à l'extinction des feux

Les sorties totales ou partielles des couloirs à l'extinction des feux seront sanctionnées par le starter,

Si la formation n'est pas satisfaisante, le starter peut redonner un nouveau tour de formation à l'aide du drapeau faux départ et des feux orange clignotants,



la procédure reprend.

H - 15' : Fermeture du Parc Assistance Départ

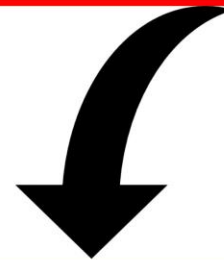

H - 5' : Fermeture de la porte de la prégrille

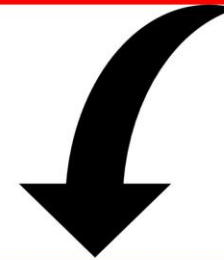

H - 3' : Evacuation mécaniciens prégrille

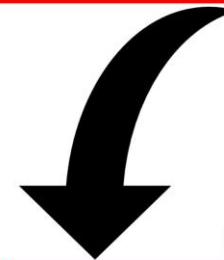

H : Départ !!



START PROCEDURE

Presence at the entrance of the park departure 15 minutes before the start time of the race, front fairing disassembled,

Pregrid closure, 5 minutes before the start time (No mechanical in pregrid),

Evacuation of mechanics, 3 minutes before departure,

Any intervention of the mechanic implies a start at the back of the pack, even in the repair zone during the formation laps,

otherwise the black flag will be presented,

2 formation lap,

Grouping at the "FORMATION" panel,



Possibility to resume his place until the Red Line,

Stay in the hallways and acceleration when the lights go out.

The total or partial exits of the corridors when lights off will be sanctioned by the starter,

If the formation is not satisfactory, the starter can give a new formation lap using the false start flag and the orange blinker, the procedure resumes.

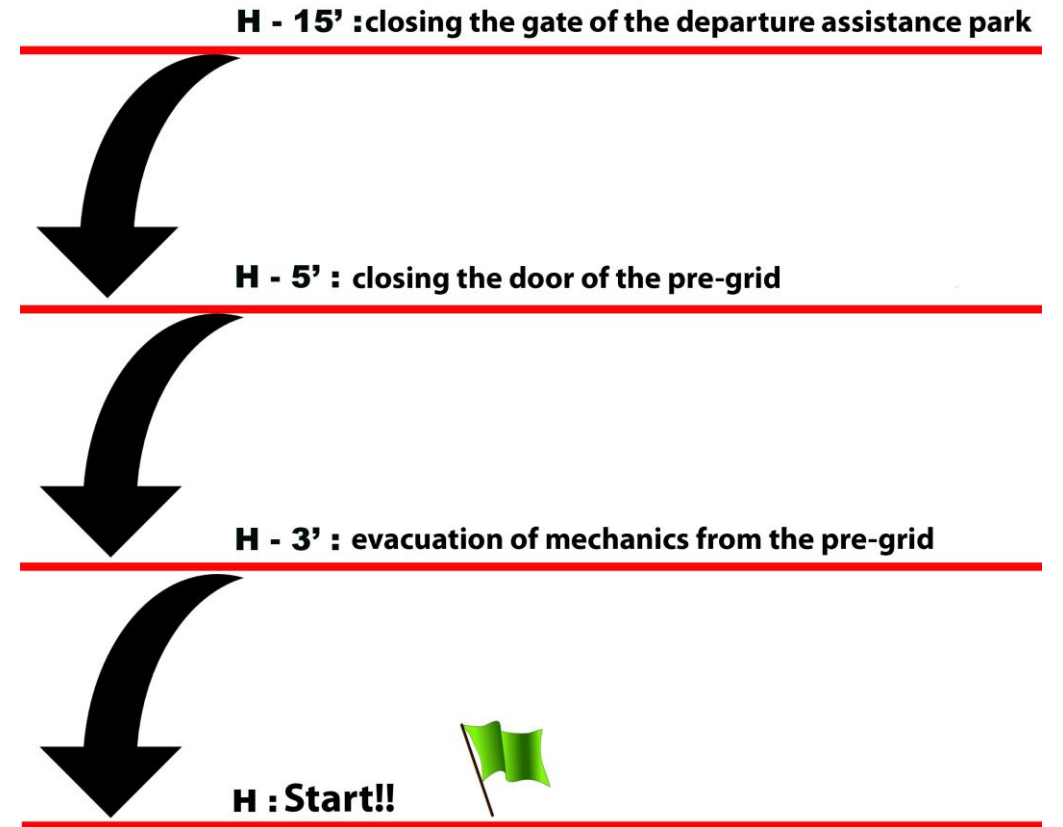

Starting Procedure

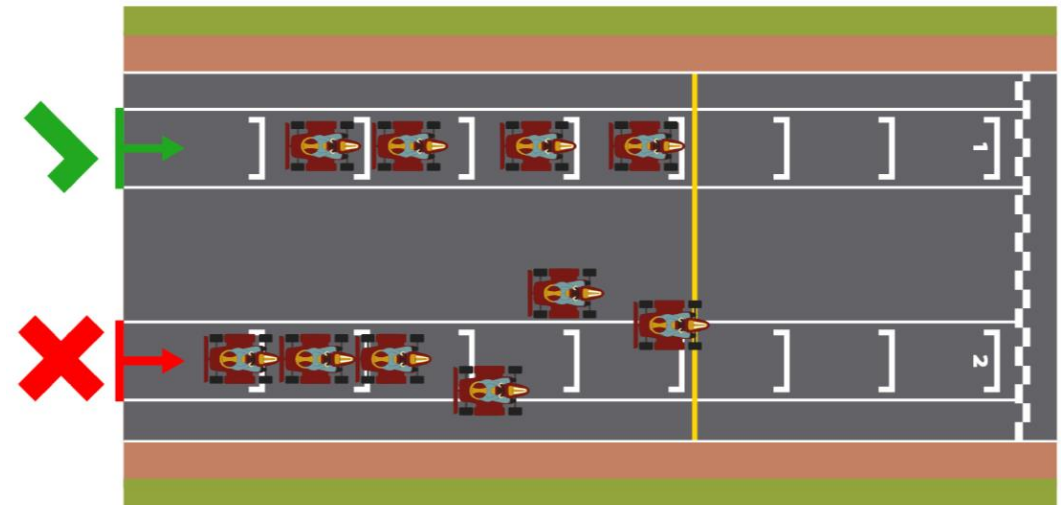
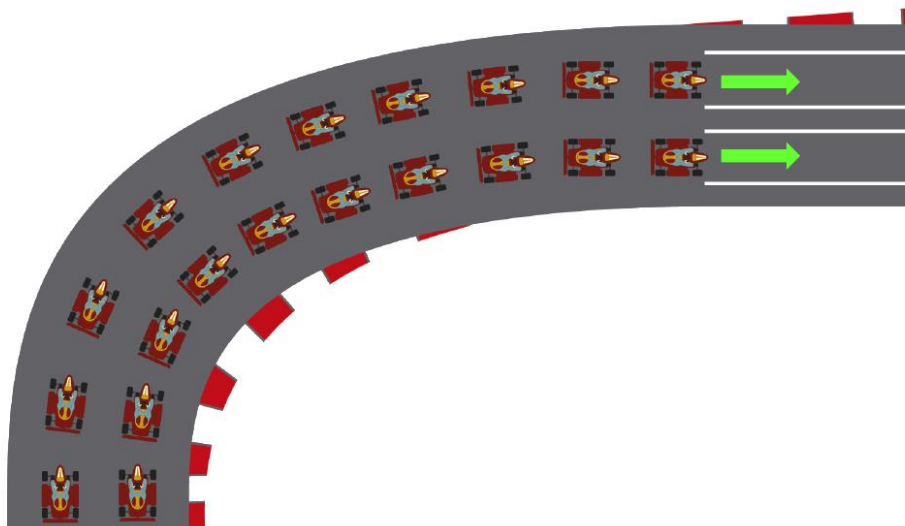
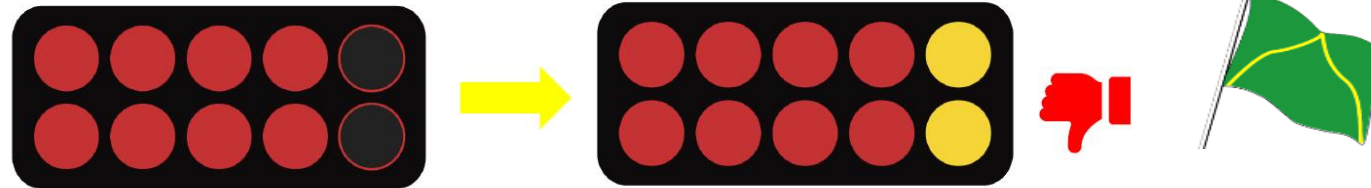
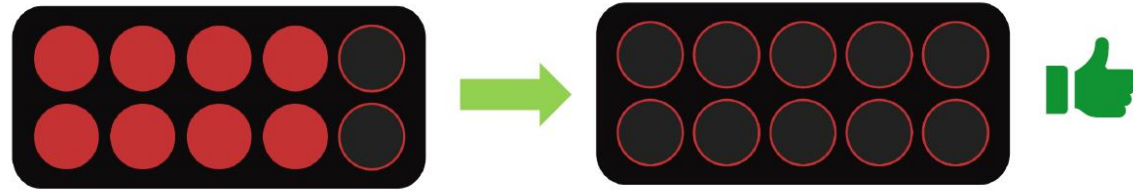

PÉNALITÉS/PENALTIES



3 s : 2 roues / 2 wheels

5 s : 4 roues / 4 wheels

04

**DRAPEAU ROUGE &
PROCEDURE SLOW**

DÉROULEMENT DE L'ÉPREUVE / PROOF OF THE EVENT

Procédure drapeau rouge

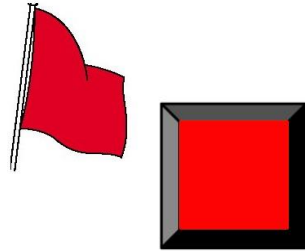

Essais qualificatifs

Retour en Parc Fermé Arrivée.

Manches qualificatives, Super Manche, finales

Dans la mesure du possible, la procédure SLOW précèdera le drapeau rouge.

Présentation du drapeau rouge (ou feux rouges), on se met en file indienne au ralenti bras levé, on vient au ralenti sur la ligne de départ et on vous donnera les instructions.

Red flag procedure

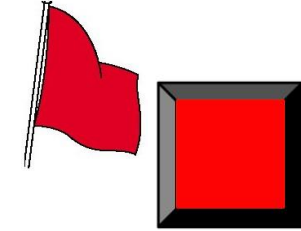

Qualifying practices

Return to Arrival "Parc Fermé"

Qualifying Heats, Super Heat, Finals

As far as possible, the SLOW procedure will precede the red flag

Presentation of the red flag (or red led flag), you drive in single file at a slow motion, we come to stop on the starting line and we will give you further instructions

PROCÉDURE SLOW / SLOW PROCEDURE



Présentation des drapeaux (ou feux) jaunes agités, accompagnés des panneaux **SLOW** aux postes commissaires

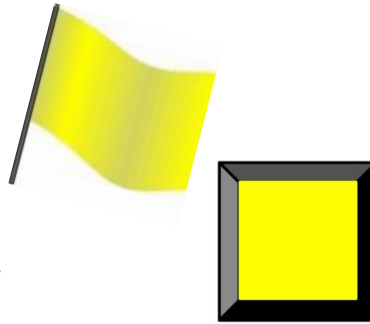

Feu orange clignotant, en direction de course

Vitesse réduite et en file indienne derrière le leader

Nombre de tour illimités en fonction de l'importance de l'intervention

Fin de procédure: lors du dernier tour de la neutralisation

Extinction du feu orange

Drapeaux jaunes fixe et panneau SLOW

Lors du passage sur la ligne de départ, présentation du drapeau vert (ou feux vert) ainsi qu'aux différents postes de commissaires

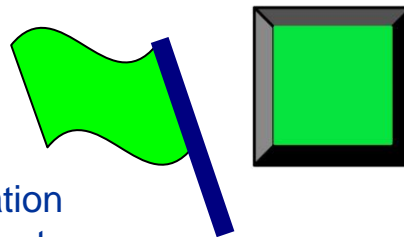

Presentation of waved yellow flags (or led flags), accompanied by **SLOW** signs on Marshals posts

Blinking orange light, in race direction

Reduced speed and in single file behind leader

Unlimited number of laps according to the importance of the intervention

End of the procedure: during the last lap of the neutralization

Extinguishing the orange light

Fixed yellow flags and **SLOW** sign

When crossing the starting line, presentation of the green flag (or led flag) and on various marshals posts

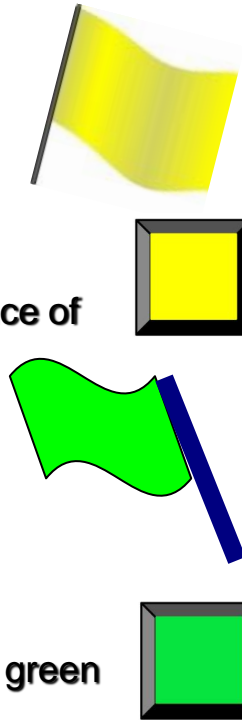

RACING BEGIN ONLY AFTER THE STARTING LINE

NO OVERTAKING BEFORE PASSING THE GREEN FLAG

**LA COURSE NE REPEND QU'APRÈS ÊTRE
PASSÉ SUR LA LIGNE DE DEPART**

**PAS DE DÉPASSEMENT AVANT D'ÊTRE PASSÉ
SOUS LE DRAPEAU VERT**

